

Genie®



Operator's Manual

with Maintenance Information

First Edition
Seventeenth Printing
Part No. 46281

GS™-2032

GS™-2632

GS™-2046

GS™-2646

GS™-3246

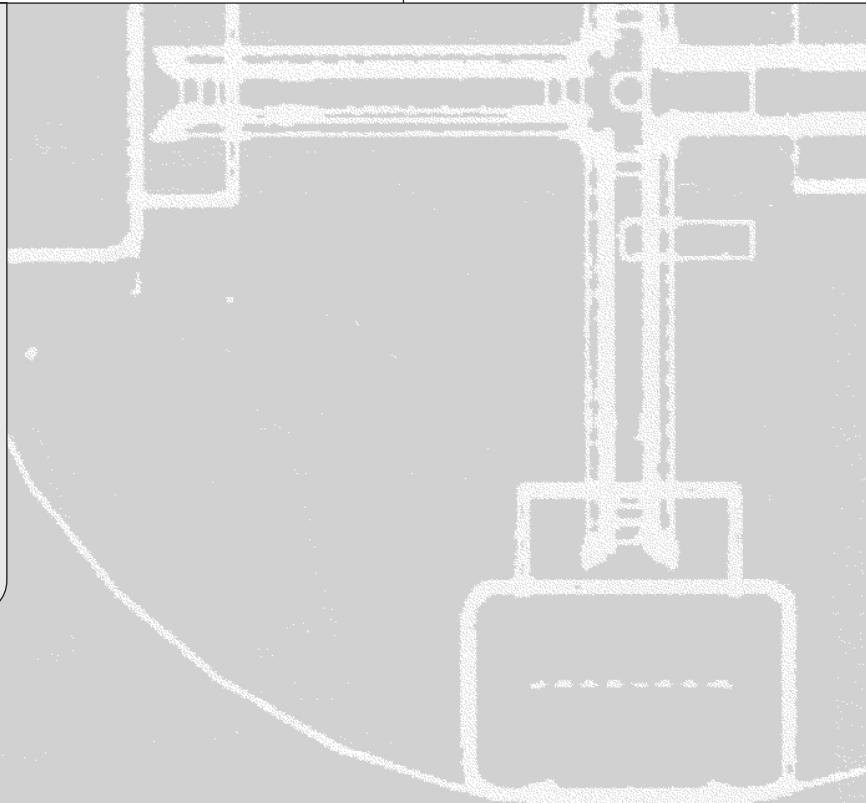

Important

Read, understand and obey these safety rules and operating instructions before operating this machine. Only trained and authorized personnel shall be permitted to operate this machine. This manual should be considered a permanent part of your machine and should remain with the machine at all times. If you have any questions, call Genie Industries.

Contents

	Page
Safety	1
Legend	9
Controls	10
Pre-operation Inspection	12
Maintenance	14
Function Tests	16
Workplace Inspection	21
Operating Instructions	22
Transport Instructions	27
Decals	28
Specifications	32

Contact us:

Internet: <http://www.genielift.com>

e-mail: techpub@genieind.com

Copyright © 1997 by Genie Industries

First Edition: Seventeenth Printing, October 2002

"Genie" is a registered trademark of Genie Industries in the U.S.A. and many other countries. "GS" is a trademark of Genie Industries.

These machines comply with
ANSI/SIA 92.6-1999.

 Printed on recycled paper

Printed in U.S.A.

Safety Rules



Danger

Failure to obey the instructions and safety rules in this manual will result in death or serious injury.

Do Not Operate Unless:

- You learn and practice the principles of safe machine operation contained in this operator's manual.

1 Avoid hazardous situations.

Know and understand the safety rules before going on to the next section.

- 2 Always perform a pre-operation inspection.
- 3 Always perform function tests prior to use.
- 4 Inspect the workplace.
- 5 Only use the machine as it was intended.

- You read, understand and obey:

Manufacturer's instructions and safety rules—safety and operator's manuals and machine decals

employer's safety rules and worksite regulations

applicable governmental regulations

- You are properly trained to safely operate the machine.

SAFETY RULES

Electrocution Hazards

This machine is **not** electrically insulated and will **not** provide protection from contact with or proximity to electrical current.

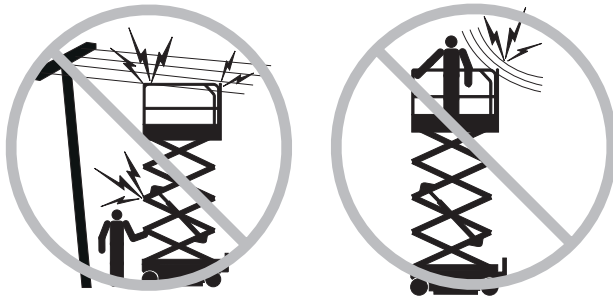

Maintain safe distances from electrical power lines and apparatus in accordance with applicable governmental regulations and the following chart.

Voltage Phase to Phase	Minimum Safe Approach Distance	
	Feet	Meters
0 to 300V	Avoid Contact	
300V to 50KV	10	3.05
50KV to 200KV	15	4.60
200KV to 350KV	20	6.10
350KV to 500KV	25	7.62
500KV to 750KV	35	10.67
750KV to 1000KV	45	13.72

Allow for platform movement, electrical line sway or sag and beware of strong or gusty winds.

Keep away from the machine if it contacts energized power lines. Personnel on the ground or in the platform must not touch or operate the machine until energized power lines are shut off.

Do not operate the machine during lightning or storms.

Do not use the machine as a ground for welding.

Tip-over Hazards

Occupants and equipment must not exceed the maximum platform capacity or the maximum capacity of the platform extension.

Maximum capacity - GS-2032

Platform retracted	800 lbs	363 kg
Platform extended - Platform only	550 lbs	249 kg
Platform extended - Extension only	250 lbs	113 kg
Maximum occupants - ANSI and CSA	2	
Maximum occupants - CE and Australia	1	
Outdoor use	1	
Indoor use only	2	



800 lbs / 363 kg



Extension only 250 lbs / 113 kg
Platform only 550 lbs / 249 kg

Maximum capacity - GS-2632

Platform retracted	500 lbs	227 kg
Platform extended - Platform only	250 lbs	113 kg
Platform extended - Extension only	250 lbs	113 kg
Maximum occupants - ANSI and CSA	2	
Maximum occupants - CE and Australia	1	
Indoor use only	2	



500 lbs / 227 kg



Extension only 250 lbs / 113 kg
Platform only 250 lbs / 113 kg

SAFETY RULES

Maximum capacity - GS-2046

Platform retracted	1200 lbs	544 kg
Platform extended - Platform only	950 lbs	431 kg
Platform extended - Extension only	250 lbs	113 kg
Maximum occupants	2	



1200 lbs / 454 kg



Extension only 250 lbs / 113 kg
Platform only 950 lbs / 431 kg

Maximum capacity - GS-2646

Platform retracted	1000 lbs	454 kg
Platform extended - Platform only	750 lbs	340 kg
Platform extended - Extension only	250 lbs	113 kg
Maximum occupants - CE	2	
Maximum occupants - Australia		
Outdoor use	1	
Indoor use only	2	



1000 lbs / 454 kg



Extension only 250 lbs / 113 kg
Platform only 750 lbs / 340 kg

Maximum capacity - GS-3246

Platform retracted	700 lbs	318 kg
Platform extended - Platform only	450 lbs	204 kg
Platform extended - Extension only	250 lbs	113 kg
Maximum occupants - ANSI and CSA	2	
Maximum occupants - CE and Australia		
Outdoor use	1	
Indoor use only	2	



700 lbs / 318 kg



Extension only 250 lbs / 113 kg
Platform only 450 lbs / 204 kg

Do not raise the platform unless the machine is on a firm, level surface.



Do not depend on the tilt alarm as a level indicator. The tilt alarm sounds on the chassis only when the machine is on a slope.

If the tilt alarm sounds:
Lower the platform. Move the machine to a firm, level surface. If the tilt alarm sounds when the platform is raised, use extreme caution to lower the platform.

Do not alter or disable the limit switches.

Do not drive over 0.5 mph / 0.7 km/h with the platform raised.

SAFETY RULES

Do not operate the machine in strong or gusty winds. Do not increase the surface area of the platform or the load. Increasing the area exposed to the wind will decrease machine stability.

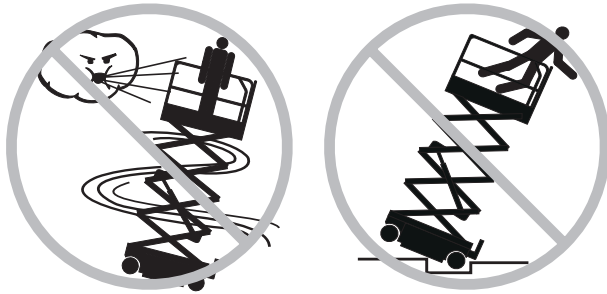

Do not drive the machine on or near uneven terrain, unstable surfaces or other hazardous conditions with the platform raised.

Use extreme care and slow speeds while driving the machine in a stowed position across uneven terrain, debris, unstable or slippery surfaces and near holes and drop-offs.

Do not push off or pull toward any object outside of the platform.



Maximum allowable manual force

GS-2032	
ANSI & CSA - 2 person	120 lbs / 534 N
CE - Indoor use only - 2 person	120 lbs / 534 N
CE - Outdoor use - 1 person	45 lbs / 200 N

GS-2632	
ANSI & CSA - 2 person	100 lbs / 445 N
CE - Indoor use only - 2 person	100 lbs / 445 N
Australia - Indoor use only - 2 person	90 lbs / 400 N

GS-2046	
ANSI & CSA - 2 person	180 lbs / 801 N
CE - Indoor use only - 2 person	180 lbs / 801 N
CE - Outdoor use - 2 person	90 lbs / 400 N

GS-2646	
ANSI & CSA - 2 person	150 lbs / 667 N
CE - Indoor use only - 2 person	150 lbs / 667 N
CE - Outdoor use - 2 person	90 lbs / 400 N
Australia - Indoor use only - 2 person	120 lbs / 534 N
Australia - Outdoor use - 1 person	45 lbs / 200 N

GS-3246	
ANSI & CSA - 2 person	105 lbs / 467 N
CE & Australia -	
Indoor use only - 2 person	105 lbs / 467 N
CE & Australia - Outdoor use - 1 person	45 lbs / 200 N

Do not alter or disable machine components that in any way affect safety and stability.

Do not place or attach fixed or overhanging loads to any part of this machine.



Do not place ladders or scaffolds in the platform or against any part of this machine.

Do not modify or alter an aerial work platform. Mounting attachments for holding tools or other materials onto the platform, toeboards or guard rail system can increase the weight in the platform and the surface area of the platform or the load.

SAFETY RULES

Do not replace items critical to machine stability with items of different weight or specification.

Do not use the machine on a moving or mobile surface or vehicle.

Be sure all tires are in good condition, castle nuts are properly tightened and cotter pins are properly installed.

Do not use batteries that weigh less than the original equipment. Batteries are used as counterweight and are critical to machine stability. Each battery must weigh 65 pounds / 30 kg.

Do not use the machine as a crane.

Do not push the machine or other objects with the platform.

Do not contact adjacent structures with the platform.

Do not tie the platform to adjacent structures.

Do not place loads outside the platform perimeter.

Do not operate the machine with the chassis trays open.

Do not use the platform controls to free a platform that is caught, snagged or otherwise prevented from normal motion by an adjacent structure. All personnel must be removed from the platform before attempting to free the platform using the ground controls.

Fall Hazards



Occupants should wear a safety belt or harness and comply with applicable governmental regulations. Attach the lanyard to the anchor provided in the platform.

Do not sit, stand or climb on the platform guard rails. Maintain a firm footing on the platform floor at all times.

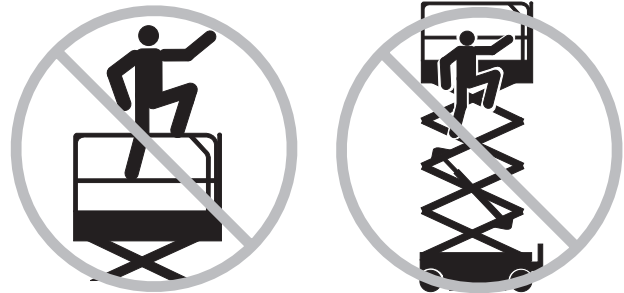

Do not climb down from the platform when raised.

Keep the platform floor clear of debris.

Attach the platform entry chain or close the entry gate before operating.

Do not operate the machine unless the guard rails are properly installed and the entry is secured for operation.

SAFETY RULES

Collision Hazards

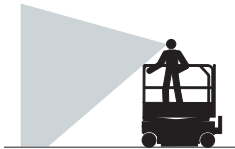

Be aware of limited sight distance and blind spots when driving or operating.

Be aware of the extended platform position when moving the machine.

The machine must be on a level surface or secured before releasing the brakes.

It is recommended that operators wear an approved hard hat when operating the machine.

Check the work area for overhead obstructions or other possible hazards.



Be aware of crushing hazards when grasping the platform guard rail.

Observe and use the color-coded direction arrows on the platform controls and platform decal plate for drive and steer functions.

No stunt driving or horseplay while operating a machine.

Do not lower the platform unless the area below is clear of personnel and obstructions.



Limit travel speed according to the condition of the ground surface, congestion, slope, location of personnel, and any other factors which may cause collision.

Do not operate a machine in the path of any crane or moving overhead machinery unless the controls of the crane have been locked out and/or precautions have been taken to prevent any potential collision.

Crushing Hazards

Keep hands and limbs out of scissors.

Use common sense and planning when operating the machine with the controller from the ground. Maintain safe distances between the operator, the machine and fixed objects.

SAFETY RULES

Component Damage Hazard

Do not use the machine as a ground for welding.

Explosion and Fire Hazard

Do not operate the machine in hazardous locations or locations where potentially flammable or explosive gases or particles may be present.

Damaged Machine Hazards

Do not use a damaged or malfunctioning machine.

Conduct a thorough pre-operation inspection of the machine and test all functions before each work shift. Immediately tag and remove from service a damaged or malfunctioning machine.

Be sure all maintenance has been performed as specified in this manual and the appropriate service manual.

Be sure all decals are in place and legible.

Be sure the operator's, safety, and responsibilities manuals are complete, legible and in the storage container located on the platform.

Bodily Injury Hazard

Do not operate the machine with a hydraulic oil or air leak. An air leak or hydraulic leak can penetrate and/or burn skin.

Decal Legend

Genie product decals use symbols, color coding and signal words to identify the following:



Safety alert symbol—used to alert personnel to potential personal injury hazards. Obey all safety messages that follow this symbol to avoid possible injury or death.



Red—used to indicate the presence of an imminently hazardous situation which, if not avoided, will result in death or serious injury.



Orange—used to indicate the presence of a potentially hazardous situation which, if not avoided, could result in death or serious injury.



Yellow with safety alert symbol—used to indicate the presence of a potentially hazardous situation which, if not avoided, may cause minor or moderate injury.



Yellow without safety alert symbol—used to indicate the presence of a potentially hazardous situation which, if not avoided, may result in property damage.



Green—used to indicate operation or maintenance information.

SAFETY RULES

Battery Safety**Burn Hazards**

Batteries contain acid. Always wear protective clothing and eyewear when working with batteries.

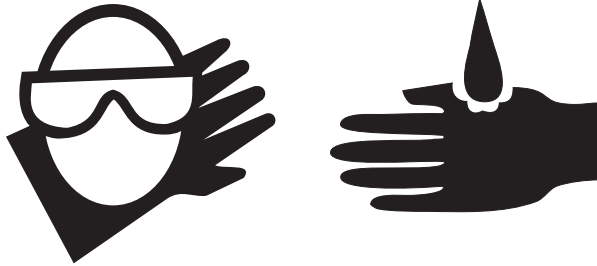

Avoid spilling or contacting battery acid. Neutralize battery acid spills with baking soda and water.

Do not expose the batteries or the charger to water or rain during charging.

Explosion Hazards

Keep sparks, flames and lighted tobacco away from batteries. Batteries emit an explosive gas.

The battery tray should remain open during the entire charging cycle.

Do not contact the battery terminals or the cable clamps with tools that may cause sparks.

Component Damage Hazard

Do not use any battery charger greater than 24V to charge the batteries.

Electrocution Hazards

Connect the battery charger to a grounded, AC 3-wire electrical outlet only.

Inspect daily for damaged cord, cables and wires. Replace damaged items before operating.

Avoid electrical shock from contact with battery terminals. Remove all rings, watches and other jewelry.

Tip-over Hazard

Do not use batteries that weigh less than the original equipment. Batteries are used as counterweight and are critical to machine stability. Each battery must weigh 65 pounds / 30 kg.

Lifting Hazard

Use the appropriate number of people and proper lifting techniques when lifting batteries.

Legend

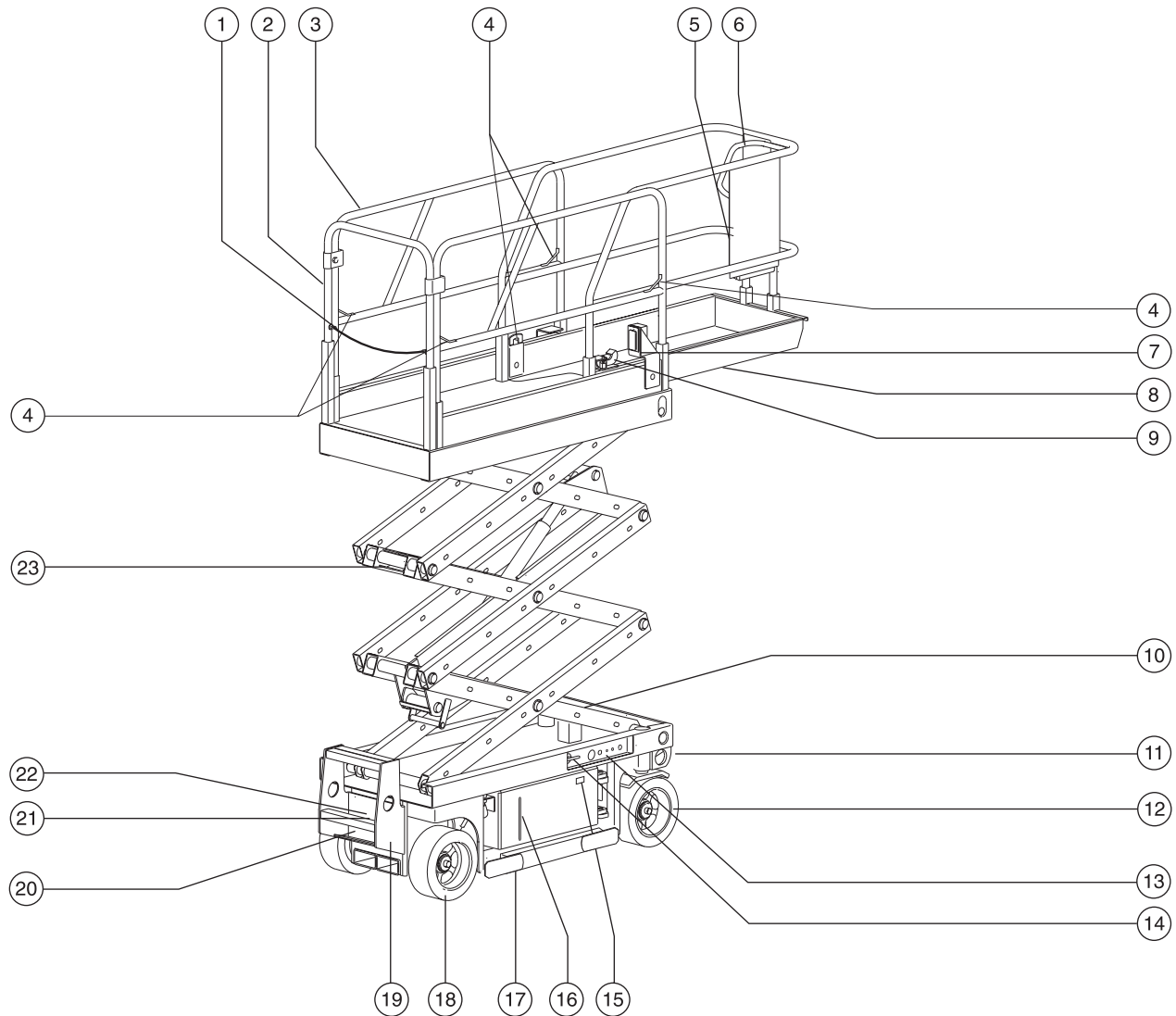

- | | | |
|--------------------------------------|--|---|
| 1 Platform entry chain or entry gate | 9 Platform extension release pedal | 17 Pothole guard |
| 2 Platform entry rail | 10 Tilt alarm (under cover) | 18 Non-steer tire |
| 3 Platform guard rails | 11 Transport tie-down | 19 Entry ladder/transport tie-down |
| 4 Lanyard anchorage point | 12 Steer tire | 20 Battery charger |
| 5 Manual storage container | 13 Ground controls | 21 Brake release pump knob |
| 6 Platform controls | 14 Auxiliary lowering knob or button or switch | 22 Brake release knob |
| 7 GFCI outlet | 15 LED diagnostic readout | 23 Safety arm
(GS-3246: safety arm located above cylinder mount) |
| 8 Platform extension | 16 Hydraulic oil level indicator | |

Controls

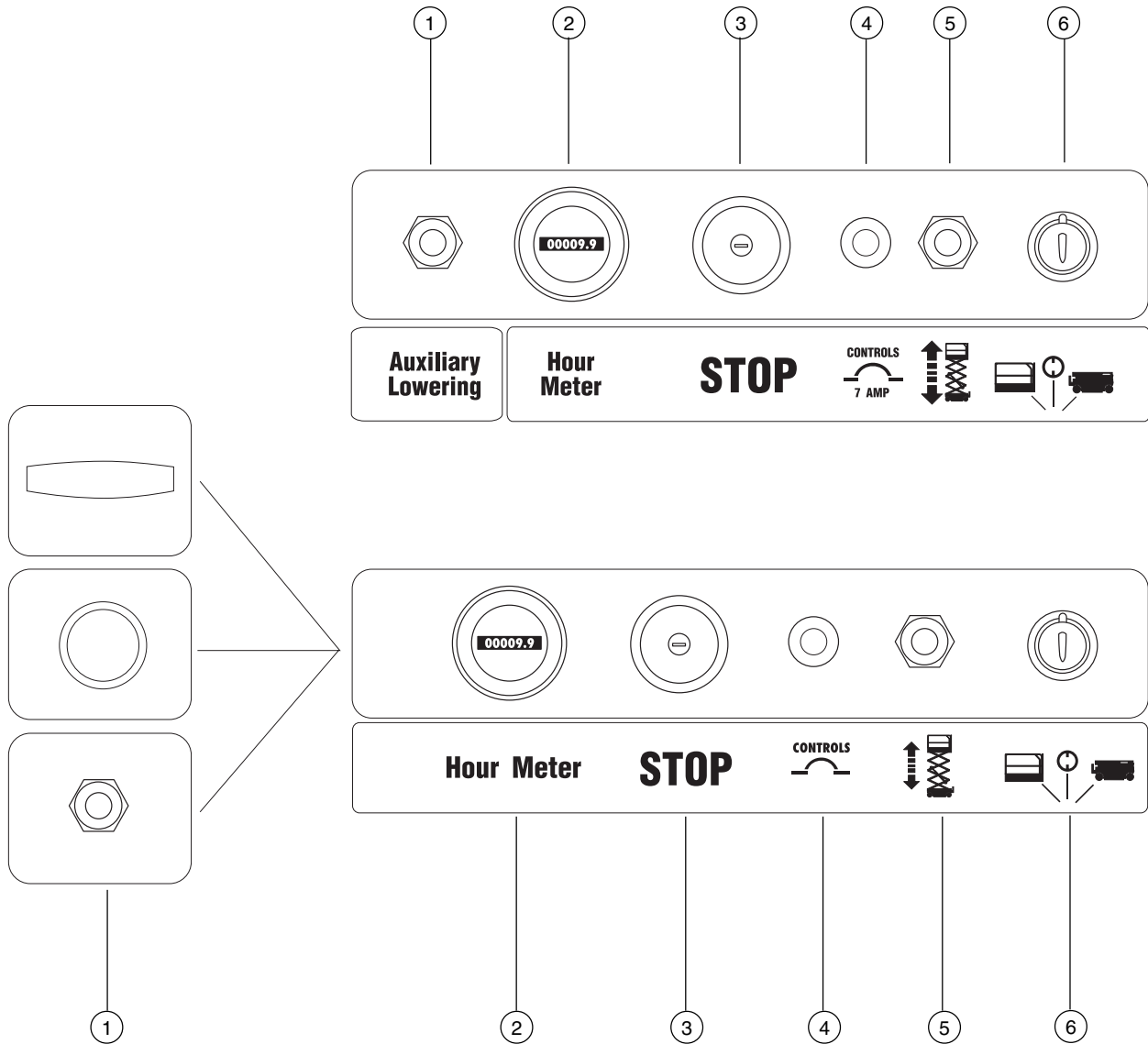

Ground Control Panel

- 1 Auxiliary lowering/manual lowering toggle switch or knob or button
- 2 Hour meter

- 3 Red Emergency Stop button
- 4 Breaker for electrical circuits
- 5 Platform up/down toggle switch

- 6 Key switch for platform/off/ground selection

CONTROLS

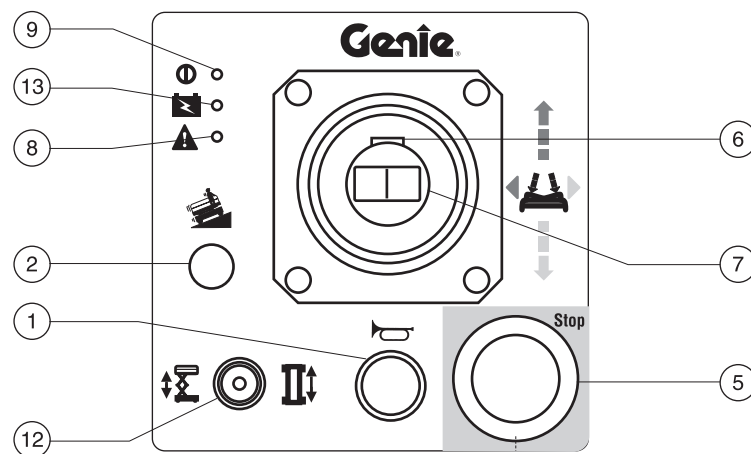
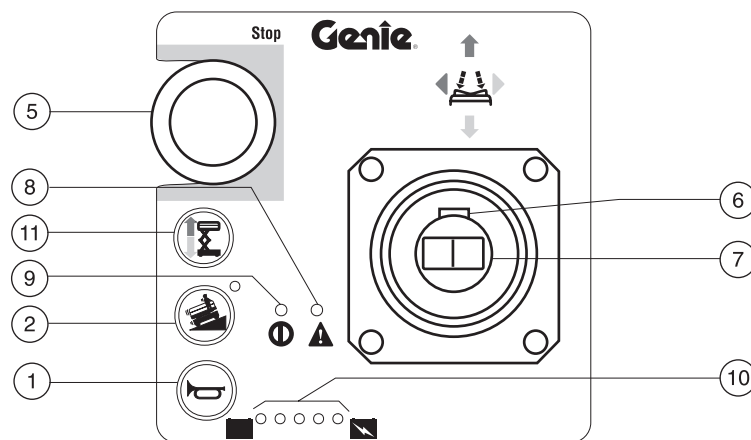
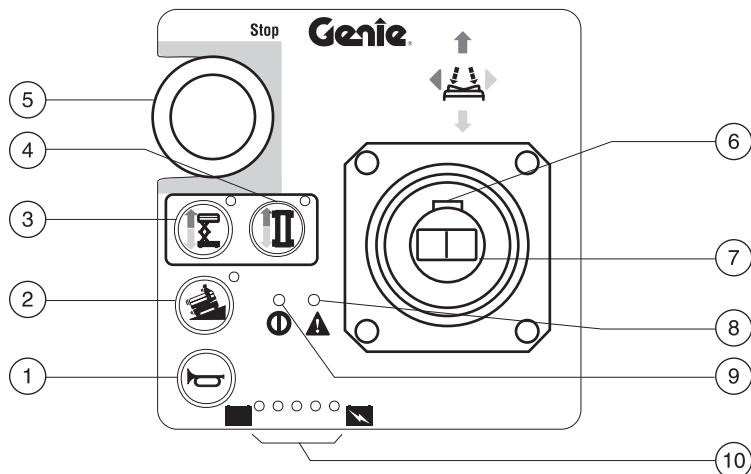



Joystick Controller

- 1 Horn
- 2 Machine on incline symbol: Low speed operation for inclines
- 3 Lift function select button with indicator light
- 4 Drive function select button with indicator light
- 5 Red Emergency Stop button
- 6 Function enable switch
- 7 Proportional control handle for lift and drive functions and thumb rocker for steer function
- 8 Error indicator light
- 9 Power light
- 10 Battery level indicator
- 11 Lift function enable button
- 12 Lift/drive select toggle switch
- 13 Low battery indicator light

The symbols shown below appear in the text in this operator's manual as an aid to identifying operating instructions.

Use the symbols on this page to identify which controller you have on your machine, and use the symbols in the text to identify which action to complete on your controller.

If no symbol is listed for your controller, then no action is needed.

-  Two function select buttons and Emergency Stop button in upper left corner
-  One function select button and Emergency Stop button in upper left corner
-  Emergency Stop button in lower right corner

Pre-operation Inspection



Do Not Operate Unless:

- You learn and practice the principles of safe machine operation contained in this operator's manual.
 - 1 Avoid hazardous situations.
 - 2 Always perform a pre-operation inspection.**
- Know and understand the pre-operation inspection before going on to the next section.**
- 3 Always perform function tests prior to use.
- 4 Inspect the workplace.
- 5 Only use the machine as it was intended.

Fundamentals

It is the responsibility of the operator to perform a pre-operation inspection and routine maintenance.

The pre-operation inspection is a visual inspection performed by the operator prior to each work shift. The inspection is designed to discover if anything is apparently wrong with a machine before the operator performs the function tests.

The pre-operation inspection also serves to determine if routine maintenance procedures are required. Only routine maintenance items specified in this manual may be performed by the operator.

Refer to the list on the next page and check each of the items and locations for modifications, damage or loose or missing parts.

A damaged or modified machine must never be used. If damage or any variation from factory delivered condition is discovered, the machine must be tagged and removed from service.

Repairs to the machine may only be made by a qualified service technician, according to the manufacturer's specifications. After repairs are completed, the operator must perform a pre-operation inspection again before going on to the function tests.

Scheduled maintenance inspections shall be performed by qualified service technicians, according to the manufacturer's specifications and the requirements listed in the responsibilities manual.

PRE-OPERATION INSPECTION

Pre-operation Inspection

- Be sure that the operator's, safety and responsibilities manuals are complete, legible and in the storage container located on the platform.
- Be sure that all decals are legible and in place. See Decals section.
- Check for hydraulic oil leaks and proper oil level. Add oil if needed. See Maintenance section.
- Check for battery fluid leaks and proper fluid level. Add distilled water if needed. See Maintenance section.

Check the following components or areas for damage, modifications and improperly installed or missing parts:

- Electrical components, wiring and electrical cables
- Hydraulic power unit, tank, hoses, fittings, cylinders and manifolds
- Battery pack and connections
- Drive motors
- Wearpads
- Tires and wheels
- Limit switches, alarms and horn
- Nuts, bolts and other fasteners
- Platform entry chain (if equipped)
- Platform entry gate (if equipped)
- Beacon and alarms (if equipped)
- Brake release components
- Safety arm
- Pothole guards

- Platform extension
- Scissor pins and retaining fasteners
- Platform control joystick
- Generator (if equipped)
- Counterweight (if equipped)

Check entire machine for:

- Cracks in welds or structural components
- Dents or damage to machine
- Be sure that all structural and other critical components are present and all associated fasteners and pins are in place and properly tightened.
- Side rails are installed and bolts are fastened
- Be sure that the chassis trays are in place, latched and properly connected.

Maintenance



Observe and Obey:

- ☑ Only routine maintenance items specified in this manual shall be performed by the operator.
- ☑ Scheduled maintenance inspections shall be completed by qualified service technicians, according to the manufacturer's specifications and the requirements specified in the responsibilities manual.

Maintenance Symbols Legend

NOTICE

The following symbols have been used in this manual to help communicate the intent of the instructions. When one or more of the symbols appear at the beginning of a maintenance procedure, it conveys the meaning below.



Indicates that tools will be required to perform this procedure.



Indicates that new parts will be required to perform this procedure.

Check the Hydraulic Oil Level



Maintaining the hydraulic oil at the proper levels is essential to machine operation. Improper hydraulic oil levels can damage hydraulic components. Daily checks allow the inspector to identify changes in oil level that might indicate the presence of hydraulic system problems.

NOTICE

Perform this procedure with the platform in the stowed position.

- 1 Visually inspect the oil level in the hydraulic tank through the sight gauge in the side of the power unit module.
- ⦿ Result: The hydraulic oil level should be within the full and add marks on the oil level indicator decal.
- 2 Add oil if necessary. Do not overfill.

Hydraulic oil specifications

Hydraulic oil type	Refer to machine decal
--------------------	------------------------

MAINTENANCE

Check the Batteries



Proper battery condition is essential to good engine performance and operational safety. Improper fluid levels or damaged cables and connections can result in engine component damage and hazardous conditions.

NOTICE This procedure does not need to be performed on machines with sealed or maintenance-free batteries.

⚠ WARNING Electrocutation hazard. Contact with hot or live circuits may result in death or serious injury. Remove all rings, watches and other jewelry.

⚠ WARNING Bodily injury hazard. Batteries contain acid. Avoid spilling or contacting battery acid. Neutralize battery acid spills with baking soda and water.

NOTICE Perform this test after fully charging the batteries.

- 1 Put on protective clothing and eye wear.
- 2 Be sure that the battery cable connections are tight and free of corrosion.
- 3 Be sure that the battery retaining fasteners are in place and secure.
- 4 Remove the battery vent caps.
- 5 Check the battery acid level of each battery. If needed, replenish with distilled water to the bottom of the battery fill tube. Do not overfill.
- 6 Install the vent caps.

Scheduled Maintenance

Maintenance performed quarterly, annually and every two years must be completed by a person trained and qualified to perform maintenance on this machine according to the procedures found in the service manual for this machine.

Machines that have been out of service for more than three months must receive the quarterly inspection before they are put back into service.

Function Tests



Do Not Operate Unless:

- You learn and practice the principles of safe machine operation contained in this operator's manual.
 - 1 Avoid hazardous situations.
 - 2 Always perform a pre-operation inspection.
 - 3 Always perform function tests prior to use.**

Know and understand the function tests before going on to the next section.

 - 4 Inspect the workplace.
 - 5 Only use the machine as it was intended.

Fundamentals

The function tests are designed to discover any malfunctions before the machine is put into service. The operator must follow the step-by-step instructions to test all machine functions.

A malfunctioning machine must never be used. If malfunctions are discovered, the machine must be tagged and removed from service. Repairs to the machine may only be made by a qualified service technician, according to the manufacturer's specifications.

After repairs are completed, the operator must perform a pre-operation inspection and function tests again before putting the machine into service.

The symbols shown below appear in the text in this operator's manual as an aid to identifying operating instructions.

Use the symbols on this page and page 11 to identify which controller you have on your machine, and use the symbols in the text to identify which action to complete on your controller.

If no symbol is listed for your controller, then no action is needed.



Two function select buttons and Emergency Stop button in upper left corner



One function select button and Emergency Stop button in upper left corner



Controller with Emergency Stop button in lower right corner

FUNCTION TESTS

- 1 Select a test area that is firm, level and free of obstruction.
- 2 Be sure the battery pack is connected.

At the Ground Controls

- 3 Pull out the platform and ground red Emergency Stop buttons to the on position.
- 4 Turn the key switch to ground control.
- 5 Observe the diagnostic LED readout.

⊙ Result: LED should read 23 or --.

Test Emergency Stop

- 6 Push in the ground red Emergency Stop button to the off position.
- ⊙ Result: No functions should operate.
- 7 Pull out the red Emergency Stop button to the on position.

Test the Up/Down Functions

The audible warnings on this machine and the standard horn all come from the same central alarm. The horn is a constant tone. The descent alarm sounds at 60 beeps per minute. The alarm that goes off when the pothole guards have not deployed sounds at 300 beeps per minute. The alarm that goes off when the machine is not level sounds at 600 beeps per minute. An optional automotive-style horn is also available.

- 8 Activate the up function.
- ⊙ Result: The platform should raise.
- 9 Activate the down function.
- ⊙ Result: The platform should lower. The descent alarm should sound while the platform is lowering.

Test Auxiliary Lowering/Manual Lowering

- 10 Activate the up function and raise the platform approximately 2 feet / 60 cm.
 - 11 Activate the auxiliary lowering/manual lowering function. Move the toggle switch OR pull the knob OR push the button.
- ⊙ Result: The platform should lower. The descent alarm will not sound.
- 12 Turn the key switch to platform control.

At the Platform Controls

Test Emergency Stop

- 13 Push in the platform red Emergency Stop button to the off position.
- ⊙ Result: No functions should operate.

Test the Horn

- 14 Pull the red Emergency Stop button out to the on position.
 - 15 Push the horn button.
- ⊙ Result: The horn should sound.



FUNCTION TESTS

Test the Function Enable Switch

- 16 Do not hold the function enable switch.
- 17 Slowly move the control handle in the direction indicated by the blue arrow, then in the direction indicated by the yellow arrow.

⦿ Result: No functions should operate.

Test the Up/Down Functions



- 18  Press the lift function select button.
-  Press and hold the lift function enable button.
-  Move the lift/drive selector switch to the lift position (if equipped).

- 19 Press and hold the function enable switch on the control handle.
- 20 Slowly move the control handle in the direction indicated by the blue arrow.
- ⦿ Result: The platform should raise. The pothole guards should deploy.
- 21 Release the control handle.
- ⦿ Result: The platform should stop raising.
- 22 Press and hold the function enable switch. Slowly move the control handle in the direction indicated by the yellow arrow.
- ⦿ Result: The platform should lower. The descent alarm should sound while the platform is lowering.

CE models: When lowering the platform, the platform should stop when it is 7 feet / 2.1 m from the ground. Be sure the area below the platform is clear of personnel and obstructions before continuing. To continue lowering, release the control handle, wait 5 seconds, then move the control handle again.

Test the Steering

Note: When performing the steer and drive function tests, stand in the platform facing the steer end of the machine.

- 23  Press the drive function select switch.
-  Move the lift/drive selector switch to the drive position (if equipped).

- 24 Press and hold the function enable switch on the control handle.
- 25 Depress the thumb rocker switch on top of the control handle in the direction identified by the blue triangle on the control panel.
- ⦿ Result: The steer wheels should turn in the direction that the blue triangle points on the control panel.
- 26 Depress the thumb rocker switch in the direction identified by the yellow triangle on the control panel.
- ⦿ Result: The steer wheels should turn in the direction that the yellow triangle points on the control panel.

FUNCTION TESTS

Test Drive and Braking

27 Press and hold the function enable switch on the control handle.

28 Slowly move the control handle in the direction indicated by the blue arrow on the control panel until the machine begins to move, then return the handle to the center position.

- ⦿ Result: The machine should move in the direction that the blue arrow points on the control panel, then come to an abrupt stop.

29 Slowly move the control handle in the direction indicated by the yellow arrow on the control panel until the machine begins to move, then return the handle to the center position.

- ⦿ Result: The machine should move in the direction that the yellow arrow points on the control panel, then come to an abrupt stop.

Note: The brakes must be able to hold the machine on any slope it is able to climb.

Test Limited Drive Speed

30  Press the lift function select button.

 Press and hold the lift function enable button.

 Move the lift/drive selector switch to the lift position (if equipped).

31 Press and hold the function enable switch on the control handle. Raise the platform approximately 4 feet / 1.2 m from the ground.

- ⦿ Result: The pothole guards should deploy.

32  Press the drive function select switch.

 Move the lift/drive selector switch to the drive position (if equipped).

33 Press and hold the function enable switch on the control handle. Slowly move the control handle to the full drive position.

- ⦿ Result: The maximum achievable drive speed with the platform raised should not exceed 0.75 feet per second / 23 cm per second.

If the drive speed with the platform raised exceeds 0.75 feet per second / 23 cm per second, immediately tag and remove the machine from service.

Test the Tilt Sensor Operation

Note: Perform this test from the ground with the platform controller. Do not stand in the platform.

34 Fully lower the platform.

35 Place a 2x4 or similar piece of wood under both wheels on one side and drive the machine up onto them.

36 Raise the platform approximately 7 feet / 2.1 m from the ground.

Machines produced before 01-01-02:

- ⦿ Result: The tilt alarm will sound at 600 beeps per minute.

CE and Australia models: The drive function and the lift function will not operate.

Proceed to step 38.

FUNCTION TESTS

Machines produced after 12-31-01:

- ⦿ Result: The platform should stop and the tilt alarm will sound at 600 beeps per minute.
- 37 Move the drive control handle in the direction indicated by the blue arrow, then move the drive control handle in the direction indicated by the yellow arrow.
- ⦿ Result: The drive function should not work in either direction.
- 38 Lower the platform and remove both pieces of wood.

Test the Pothole Guards

Note: The pothole guards should automatically deploy when the platform is raised. The pothole guards activate two limit switches which control the machine drive speed. If the pothole guards do not deploy and the platform is raised above 6 feet / 1.8 m, an alarm sounds and the machine will not drive.

- 39 Raise the platform.
- ⦿ Result: When the platform is raised 4 feet / 1.2 m from the ground, the pothole guards should deploy.
- 40 Press on the pothole guards on one side, and then the other.
- ⦿ Result: The pothole guards should not move.

- 41 Lower the platform.
- ⦿ Result: The pothole guards should return to the stowed position.
- 42 Place a 2x4 or similar piece of wood under a pothole guard. Raise the platform.
- ⦿ Result: Before the platform is raised 7 feet / 2.1 m from the ground, an alarm should sound and the drive function should not work.
- 43 Lower the platform and remove the 2x4.

**Test the Platform Limit Switch
- GS-3246 models**

Note: Some GS-3246 models are equipped with a counterweight in the chassis and do not require this test. The counterweight is gray and measures 28 inches / 71 cm by 15 inches / 38 cm. Open the chassis trays to see if your machine is equipped with this counterweight. If not, you must perform this test.

- 44 Raise the platform to approximately 26 feet / 7.9 m.
- 45 Press and hold the function enable switch on the control handle.
- 46 Slowly move the control handle to the full drive position.
- ⦿ Result: The drive function should not operate.
- Lower the platform to drive.

Workplace Inspection



Do Not Operate Unless:

- You learn and practice the principles of safe machine operation contained in this operator's manual.

- 1 Avoid hazardous situations.
- 2 Always perform a pre-operation inspection.
- 3 Always perform function tests prior to use.

4 Inspect the workplace.

Know and understand the workplace inspection before going on to the next section.

- 5 Only use the machine as it was intended.

Fundamentals

The workplace inspection helps the operator determine if the workplace is suitable for safe machine operation. It should be performed by the operator prior to moving the machine to the workplace.

It is the operator's responsibility to read and remember the workplace hazards, then watch for and avoid them while moving, setting up and operating the machine.

Workplace Inspection

Be aware of and avoid the following hazardous situations:

- drop-offs or holes
- bumps, floor obstructions or debris
- overhead obstructions and high voltage conductors
- hazardous locations
- inadequate surface support to withstand all load forces imposed by the machine
- wind and weather conditions
- the presence of unauthorized personnel
- other possible unsafe conditions

Operating Instructions



Do Not Operate Unless:

- You learn and practice the principles of safe machine operation contained in this operator's manual.
 - 1 Avoid hazardous situations.
 - 2 Always perform a pre-operation inspection.
 - 3 Always perform function tests prior to use.
 - 4 Inspect the workplace.
 - 5 **Only use the machine as it was intended.**

Fundamentals

The Operating Instructions section provides instructions for each aspect of machine operation. It is the operator's responsibility to follow all the safety rules and instructions in the operator's, safety and responsibilities manuals.

Using the machine for anything other than lifting personnel and tools to an aerial work site is unsafe and dangerous.

Only trained and authorized personnel should be permitted to operate a machine. If more than one operator is expected to use a machine at different times in the same work shift, they must all be qualified operators and are all expected to follow all safety rules and instructions in the operator's, safety and responsibilities manuals. That means every new operator should perform a pre-operation inspection, function tests, and a workplace inspection before using the machine.

OPERATING INSTRUCTIONS

Emergency Stop

Push in the red Emergency Stop button to the off position at the ground controls or the platform controls to stop all functions.

Repair any function that operates when either red Emergency Stop button is pushed in.

Auxiliary Lowering/Manual Lowering

- 1 Activate the auxiliary lowering/manual lowering function. Move the toggle switch OR pull the knob OR push the button.

Operation From Ground

- 1 Turn the key switch to ground control.
- 2 Pull out both ground and platform red Emergency Stop buttons to the on position.
- 3 Be sure the battery pack is connected before operating the machine.

To Position Platform



- 1 Move the up/down toggle switch according to the markings on the control panel.

Drive and steer functions are not available from the ground controls.

Operation From Platform



- 1 Turn the key switch to platform control.
- 2 Pull out the ground and platform red Emergency Stop buttons to the on position.
- 3 Be sure the battery pack is connected before operating the machine.

To Position Platform

- 1  Press the lift function select button.
 Press and hold the lift function enable button.
 Move the lift/drive selector switch to the lift position (if equipped).
- 2 Press and hold the function enable switch on the control handle.
- 3 Move the control handle according to the markings on the control panel.



CE models: When lowering the platform, the platform should stop when it is 7 feet / 2.1 m from the ground. Be sure the area below the platform is clear of personnel and obstructions before continuing. To continue lowering, release the control handle, wait 5 seconds, then move the control handle again.

To Steer

- 1  Press the drive function select button.
 Move the lift/drive selector switch to the drive position.
- 2 Press and hold the function enable switch on the control handle.
- 3 Turn the steer wheels with the thumb rocker switch located on the top of the control handle.

OPERATING INSTRUCTIONS

To Drive

- 1  Press the drive function select button.
 Move the lift/drive selector switch to the drive position.
- 2 Press and hold the function enable switch on the control handle.
- 3 Increase speed: Slowly move the control handle off center.
Decrease speed: Slowly move the control handle toward center.
Stop: Return the control handle to center or release the function enable switch.

Use the color-coded direction arrows on the platform controls and on the platform to identify the direction the machine will travel.

Machine travel speed is restricted when the platform is raised.

Battery condition will affect machine performance. Machine drive speed and function speed will drop when the low battery indicator light is on or when the last light on the battery level indicator is flashing.

Error Indicator Light On

If the error indicator light is on, push in and pull out the red Emergency Stop button to reset the system.



If the light stays on, tag and remove the machine from service.

Drive Select Switch

Machine on incline symbol:
Low range operation for inclines



Move the toggle switch down for normal drive operation.

OPERATING INSTRUCTIONS

To Extend and Retract Platform

- 1 Step on the platform extension release pedal on the platform toeboard.
- 2 Grasp the platform guard rails and carefully push to extend the platform to the mid-position stop.
- 3 Step on the release pedal again and push to fully extend the platform.

Do not stand on the platform extension while trying to extend it.

- 4 Step on the platform extension release pedal and pull to retract the platform to the mid-position stop. Step again to fully retract the platform.

GS-3246 models without chassis counterweight: The platform extension limit switch will disable the drive function when the platform is extended and the platform is raised above 26 ft / 7.9 m. Lower the platform or retract the platform extension to drive the machine.

Operation From Ground with Controller

Maintain safe distances between the operator, machine and fixed objects.

Be aware of the direction the machine will travel when using the controller.

After Each Use

- 1 Select a safe parking location—firm level surface, clear of obstruction and traffic.
- 2 Lower the platform.
- 3 Turn the key switch to the off position and remove the key to secure from unauthorized use.
- 4 Chock the wheels.
- 5 Charge the batteries.

OPERATING INSTRUCTIONS



Battery and Charger Instructions

Observe and Obey:

- Do not use an external charger or booster battery.
- Charge the battery in a well-ventilated area.
- Use proper AC input voltage for charging as indicated on the charger.
- Use only Genie authorized battery and charger.

To Charge Battery

- 1 Be sure the batteries are connected before charging the batteries.
- 2 Open the battery compartment. The compartment should remain open for the entire charging cycle.
- 3 Remove the battery vent caps and check the battery acid level. If necessary, add only enough distilled water to cover the plates. Do not overfill prior to the charge cycle.
- 4 Replace the battery vent caps.
- 5 Connect the battery charger to a grounded AC circuit.
- 6 Turn the battery charger on.
- 7 The charger will indicate when the battery is fully charged.
- 8 Check the battery acid level when the charging cycle is complete. Replenish with distilled water to the bottom of the fill tube. Do not overfill.

Dry Battery Filling and Charging Instructions

- 1 Remove the battery vent caps and permanently remove the plastic seal from the battery vent openings.
- 2 Fill each cell with battery acid (electrolyte) until the level is sufficient to cover the plates.

Do not fill to maximum level until the battery charge cycle is complete. Overfilling can cause the battery acid to overflow during charging. Neutralize battery acid spills with baking soda and water.

- 3 Install the battery vent caps.
- 4 Charge the battery.
- 5 Check the battery acid level when the charging cycle is complete. Replenish with distilled water to the bottom of the fill tube. Do not overfill.

Transport Instructions



Observe and Obey:

- Common sense and planning must be applied to control the movement of the machine when lifting it with a crane or forklift.
- The transport vehicle must be parked on a level surface.
- The transport vehicle must be secured to prevent rolling while the machine is being loaded.
- Be sure the vehicle capacity, loading surfaces and chains or straps are sufficient to withstand the machine weight. See the serial plate for the machine weight.
- The machine must be on a level surface or secured before releasing the brakes.

Securing to Truck or Trailer for Transit

Always chock the machine wheels in preparation for transport.

Use the tie-down points on the chassis for anchoring down to the transport surface.

Use chains or straps of ample load capacity.

Turn the key switch to the off position and remove the key before transporting.

Inspect the entire machine for loose or unsecured items.

Brake Release Operation

- 1 Chock the wheels to prevent the machine from rolling.
- 2 Be sure the winch line is properly secured to the drive chassis tie points and the path is clear of all obstructions.
- 3 Turn the brake release knob counterclockwise to open the brake valve.
- 4 Pump the brake release pump knob.

After the machine is loaded:

- 1 Chock the wheels to prevent the machine from rolling.
- 2 Turn the brake release knob clockwise to reset the brakes.

Towing the Genie GS-2032, the GS-2632, the GS-2046, the GS-2646 or the GS-3246 is not recommended. If the machine must be towed, do not exceed 2 mph / 3.2 km/h.

Decals

Decal Inspection

Use the pictures on the next pages to verify that all decals are legible and in place.

Below is a numerical list with quantities and descriptions.

Part No.	Description	Quantity
28161	Warning - Crush Hand	2
28164	Notice - Hazardous Materials	1
28171	Label - No Smoking	1
28174	Label - Power to Platform, 230V	2
28175	Caution - Compartment Access	1
28176	Notice - Missing Manuals	1
28235	Label - Power to Platform, 115V	2
28236	Warning - Failure To Read . . .	1
31060	Danger - Do Not Alter Limit Switch	2
31508	Notice - Power to Battery Charger	1
31785	Notice - Battery Charger Operating Instructions	1
37145	Label - Manual Lowering	1
38149	Label - Patents	1
40434	Label - Lanyard Anchorage	5
43089	Notice - Operating Instructions, Ground	1
43090	Notice - Operating Instructions, Platform	1
43091	Danger - General Safety Rules	1
43094	Ground Control Panel	1
43617	Danger - Tip-over (batteries)	1
43618	Label - Directional Arrows	2
43619	Label - Safety Arm	1
43658	Label - Power to Charger, 230V	1
43696	Danger - Electrocutation Hazard	2
44220	Danger/Notice - Brake Release Safety & Operating Instructions	1
44254	Notice - Max Cap 500 lbs, GS-2632	1
44255	Danger - Crushing Hazard	4
44736	Danger - Tilt Alarm	1
44737	Danger - Tip-over, Trays Open	2
44753	Label - LED Diagnostic Readout	1
44980	Label - Power to Charger, 115V	1
44994	Label - Hydraulic Fluid Level / Dexron	1

Part No.	Description	Quantity
46238	Notice - Error Indicator Light	1
46262	Danger - Battery/Charger Safety	1
46285	Notice - Max Cap 800 lbs, GS-2032, ANSI & CSA	1
46286	Notice - Battery Connection Diagram	1
46287	Notice - Tire Specification	4
52063	Notice - Max Cap 800 lbs, GS-2032, CE	1
52475	Label - Transport Tie-down	5
52494	Caution - Crushing Hazard	1
52560	Notice - Side Force & Wind Speed, GS-2032, CE	1
52608	Notice - Side Force, GS-2032, ANSI & CSA	1
52864	Platform Control Panel	1
62055	Cosmetic - Genie GS-2032	2
65052	Label - ECU Fault Codes	1
72833	Label - Open Latches	2
72853	Danger - Improper Use Hazard	1
72973	Cosmetic - Genie GS-2632	2
72990	Notice - Side Force & Wind Speed, GS-2632, CE	1
72992	Notice - Side Force, GS-2632, ANSI & CSA	1
82307	Notice - Side Force, GS-2632, Australia	1
82368	Label - Chevron Rykon	1
82448	Ground Control Panel	1

DECALS

GS-2032 and GS-2632

Decal Part Numbers			
each model requires 1 Capacity decal and 1 Side Force decal			
		GS-2032	GS-2632
ANSI	Capacity	46285	44254
	Side Force	52608	72992
CSA	Capacity	46285	44254
	Side Force	52608	72992
CE	Capacity	52063	44254
	Side Force	52560	72990
Australia	Capacity	52063	44254
	Side Force	52560	82307

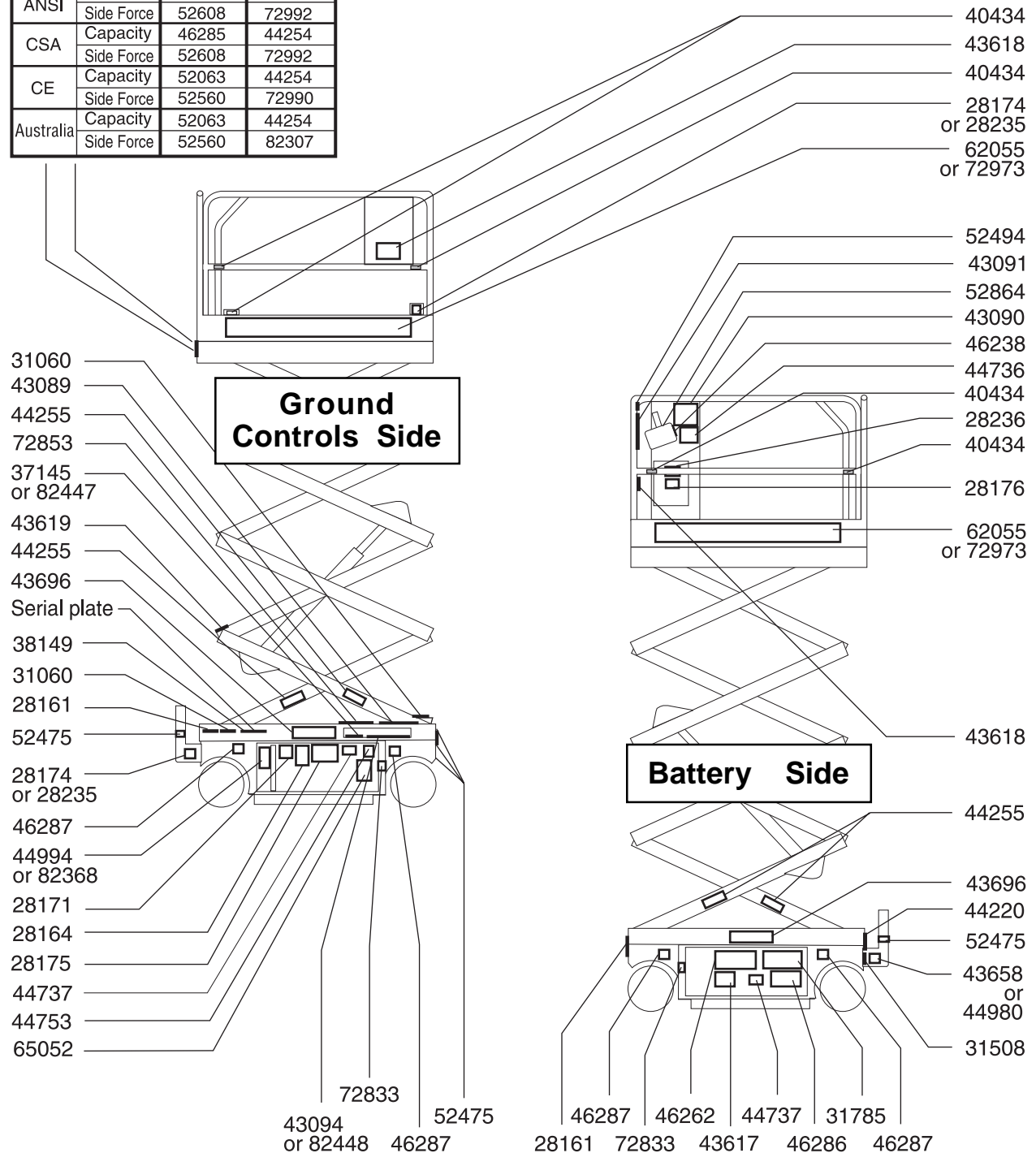

DECALS

Decal Inspection

Use the pictures on the next pages to verify that all decals are legible and in place.

Below is a numerical list with quantities and descriptions.

Part No.	Description	Quantity
28161	Warning - Crush Hand	2
28164	Notice - Hazardous Materials	1
28171	Label - No Smoking	1
28174	Label - Power to Platform, 230V	2
28175	Caution - Compartment Access	1
28176	Notice - Missing Manuals	1
28235	Label - Power to Platform, 115V	2
28236	Warning - Failure To Read . . .	1
31060	Danger - Do Not Alter Limit Switch	2
31508	Notice - Power to Battery Charger	1
31785	Notice - Battery Charger Operating Instructions	1
37145	Label - Manual Lowering	1
38149	Label - Patents	1
40434	Label - Lanyard Anchorage	5
43089	Notice - Operating Instructions, Ground	1
43090	Notice - Operating Instructions, Platform	1
43091	Danger - General Safety Rules	1
43094	Ground Control Panel	1
43617	Danger - Tip-over (batteries)	1
43618	Label - Directional Arrows	2
43619	Label - Safety Arm	1
43658	Label - Power to Charger, 230V	1
43696	Danger - Electrocutation Hazard	2
44220	Danger/Notice - Brake Release Safety & Operating Instructions	1
44254	Notice - Max Cap 500/250, GS-3246, CSA	1
44255	Danger - Crushing Hazard	4
44736	Danger - Tilt Alarm	1
44737	Danger - Tip-over, Trays Open	2
44753	Label - LED Diagnostic Readout	1
44980	Label - Power to Charger, 115V	1
44994	Label - Hydraulic Fluid Level / Dexron	1

Part No.	Description	Quantity
46238	Notice - Error Indicator Light	1
46262	Danger - Battery/Charger Safety	1
46286	Notice - Battery Connection Diagram	1
46287	Notice - Tire Specification	4
48331	Notice - Max Cap 1000 lbs, GS-2646	1
52084	Notice - Max Cap 1200 lbs, GS-2046	1
52337	Notice - Max Cap 700 lbs, GS-3246	1
52475	Label, Transport Tie-down	5
52494	Caution, Crushing Hazard	1
52561	Notice - Side Force & Wind Speed, GS-2046, CE	1
52562	Notice - Side Force & Wind Speed, GS-2646, CE	1
52563	Notice - Side Force & Wind Speed, GS-3246, CE	1
52609	Notice - Side Force, GS-2046, ANSI & CSA	1
52610	Notice - Side Force, GS-2646, ANSI & CSA	1
52864	Platform Control Panel	1
62056	Cosmetic - Genie GS-2046	2
62057	Cosmetic - Genie GS-2646	2
62058	Cosmetic - Genie GS-3246	2
65052	Label - ECU Fault Codes	1
72084	Notice - Side Force & Wind Speed, GS-3246, CE	1
72120	Notice - Max Side Force, ANSI & CSA	1
78026	Notice - Side Force, GS-2646, Australia	1
78027	Notice - Max. Capacity, GS-2646, Australia	1
78028	Notice - Max. Capacity, GS-3246, CE and Australia	1
72833	Label - Open Latches	2
72853	Danger - Improper Use Hazard	1
82368	Label - Chevron Rykon	1
82447	Label - Auxiliary Lowering	1
82448	Ground Control Panel	1

DECALS

GS-2046, GS-2646 and GS-3246

Decal Part Numbers				
each model requires 1 Capacity decal and 1 Side Force decal				
		GS-2046	GS-2646	GS-3246
ANSI	Capacity	52084	48331	52337
	Side Force	52609	52610	72120
CSA	Capacity	52084	48331	44254
	Side Force	52609	52610	72120
CE	Capacity	52084	48331	78028
	Side Force	52561	52562	52563 or 72084
Australia	Capacity	52084	78027	78028
	Side Force	52561	78026	52563 or 72084

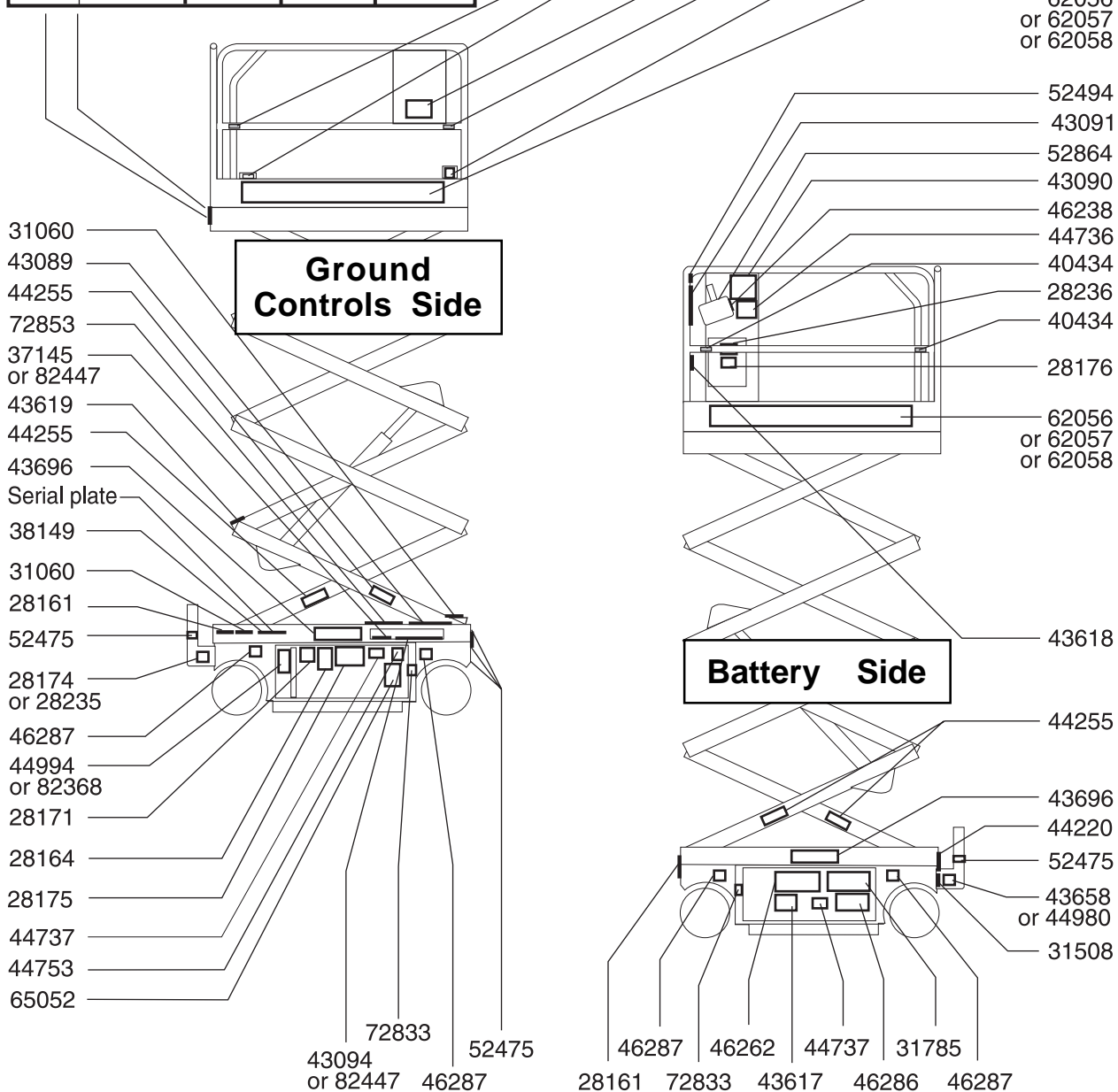

Specifications

Model	GS-2032	
Height, working maximum	26 ft	8.1 m
Height, platform maximum	20 ft	6.1 m
Height, stowed maximum Rails up - CE	82 ⁷ / ₈ in	2.1 m
Height, stowed maximum Rails up - ANSI	78 ¹ / ₂ in	1.99 m
Height, stowed maximum Rails lowered	76 ¹ / ₂ in	1.94 m
Height, stowed maximum Rails off	39 in	99 cm
Height, guard rails - ANSI, CSA and Australia	39 in	99 cm
Height, guard rails - CE	43 ¹ / ₂ in	1.1 m
Width	32 in	81.3 cm
Length, stowed	96 in	2.44 m
Length, platform extended	135 in	3.44 m
Maximum load capacity	800 lbs	363 kg
Wheelbase	73 in	1.85 m
Turning radius (outside)	92 in	2.34 m
Turning radius (inside)	0 in	0 cm
Ground clearance	4.0 in	10.2 cm
Ground clearance Pothole guards deployed	7/8 in	2.2 cm
Weight (Machine weights vary with option configurations)	See Serial Plate	
Gradeability	30%	
Airborne noise emissions Maximum sound level at normal operating workstations (A-weighted)	70 dB	
Power source	4 Batteries, 6V 245AH	
Controls	Proportional	

AC outlet in platform	standard	
Maximum hydraulic pressure (functions)	3500 psi	241.3 bar
Tires size	15 x 5 x 11 ¹ / ₄	
Hydraulic system capacity	5.5 gallons 20.8 liters	

Platform dimensions

Length x width	89 in x 31 ¹ / ₄ in 2.26 m x 79.4 cm	
Platform extension length	39 in 99 cm	

Drive speeds

Stowed, maximum	2.2 mph 3.5 km/h	
Platform raised, maximum	0.5 mph 0.8 km/h 40 ft/54.5 sec 12.2 m/54.5 sec	

Floor Loading Information	ANSI CSA & CE	Australia
GVW+Rated Load	4303 lbs 1952 kg	5306 lbs 2407 kg
Axle load, maximum	2450 lbs 1111 kg	3410 lbs 1547 kg
Wheel load, maximum	1225 lbs 555 kg	1705 lbs 773 kg
Localized pressure per tire	123 psi 8.62 kg/cm ² 845 kPa	170.5 psi 12.0 kg/cm ² 1176 kPa
Occupied pressure	218 psf 10.42 kPa	268 psf 12.85 kPa

Note: Floor loading information is approximate and does not incorporate different option configurations. It should be used only with adequate safety factors.

Continuous improvement of our products is a Genie policy.
Product specifications are subject to change without notice or obligation.

SPECIFICATIONS

Model	GS-2632	
Height, working maximum	32 ft	9.9 m
Height, platform maximum	26 ft	7.9 m
Height, stowed maximum	90 in	2.29 m
Height, stowed maximum Rails folded	68 in	1.73 m
Platform height, Stowed maximum	46 ¹ / ₈ in	1.17 m
Height, guard rails - ANSI, CSA and Australia	39 in	99.1 cm
Height, guard rails - CE	43 in	1.1 m
Width	32 in	81.3 cm
Length, stowed	96 in	2.44 m
Length, platform extended	135 in	3.44 m
Maximum load capacity	500 lbs	227 kg
Wheelbase	73 in	1.85 m
Turning radius (outside)	92 in	2.34 m
Turning radius (inside)	0 in	0 cm
Ground clearance	4.0 in	10.2 cm
Ground clearance Pothole guards deployed	7/8 in	2.2 cm
Weight (Machine weights vary with option configurations)	See Serial Plate	
Gradeability	25%	
Airborne noise emissions Maximum sound level at normal operating workstations (A-weighted)	70 dB	
Power source	4 Batteries, 6V 245AH	
Controls	Proportional	

AC outlet in platform	standard	
Maximum hydraulic pressure (functions)	3500 psi	241.3 bar
Tires size	15 x 5 x 11 ¹ / ₄	

Platform dimensions

Length x width	89 in x 31 ¹ / ₄ in 2.26 m x 79.4 cm	
Platform extension length	39 in 99 cm	

Drive speeds

Stowed, maximum	2.2 mph 3.5 km/h	
Platform raised, maximum	0.5 mph 0.8 km/h 40 ft/54.5 sec 12.2 m/54.5 sec	

Floor Loading Information

	ANSI CSA	CE Australia
GVW+Rated Load	5650 lbs 2563 kg	6020 lbs 2731 kg
Axle load, maximum	3630 lbs 1647 kg	3738 lbs 1696 kg
Wheel load, maximum	1815 lbs 823 kg	1869 lbs 848 kg
Localized pressure per tire	181.5 psi 12.77 kg/cm ² 1251 kPa	186.9 psi 13.15 kg/cm ² 1289 kPa
Occupied pressure	286 psf 13.68 kPa	304 psf 14.57 kPa

Note: Floor loading information is approximate and does not incorporate different option configurations. It should be used only with adequate safety factors.

Continuous improvement of our products is a Genie policy.
Product specifications are subject to change without notice or obligation.

SPECIFICATIONS

Model	GS-2046	
Height, working maximum	26 ft	8.1 m
Height, platform maximum	20 ft	6.1 m
Models with sliding rails		
Height, stowed maximum Rails up - CE	82 ⁷ / ₈ in	2.1 m
Height, stowed maximum Rails up - ANSI	78 ¹ / ₂ in	1.99 m
Height, stowed maximum Rails lowered	71 ³ / ₄ in	1.82 m
Height, stowed maximum Rails off	39 ¹ / ₄ in	99.7 cm
Height, guard rails - ANSI, CSA and Australia	39 in	99.1 cm
Height, guard rails - CE	43 in	1.1 m
Models with folding rails		
Height, stowed maximum	86 ¹ / ₈ in	2.19 m
Height, stowed maximum Rails folded	64 ³ / ₈ in	1.64 m
Platform height, Stowed maximum	42 ³ / ₈ in	1.08 m
All models		
Width	46 in	1.17 m
Length, stowed	96 in	2.44 m
Length, platform extended	135 in	3.44 m
Maximum load capacity	1200 lbs	544 kg
Wheelbase	73 in	1.85 m
Turning radius (outside)	92 in	2.34 m
Turning radius (inside)	0 in	0 cm
Ground clearance	4 in	10.2 cm
Ground clearance Pothole guards deployed	7 ⁷ / ₈ in	2.22 cm
Weight	See Serial Plate (Machine weights vary with option configurations)	

Gradeability	30 %	
Airborne noise emissions Maximum sound level at normal operating workstations (A-weighted)	70 dB	
Power source	4 Batteries, 6V 245AH	
Controls	Proportional	
AC outlet in platform	standard	
Maximum hydraulic pressure (functions)	3500 psi	241 bar
Tires size	15 x 5 x 11 ¹ / ₄	
Hydraulic system capacity	5 ¹ / ₂ gallons	20.8 liters

Platform dimensions

Length x width	89 x 45 ³ / ₄ in 2.26 m x 1.16m	
Platform extension length	39 in	99 cm

Drive speeds

Stowed, maximum	2.2 mph 3.5 km/h	
Platform raised, maximum	0.5 mph 0.8 km/h 40 ft/54.5 sec 12.2 m/54.5 sec	

Floor Loading Information

GVW+Rated Load	5524 lbs	2506 kg
Axle load, maximum	2900 lbs	1315 kg
Wheel load, maximum	1450 lbs	657 kg
Localized pressure per tire	145 psi	10.2 kg/cm ² 1000 kPa
Occupied pressure	194 psf	9.30 kPa

Note: Floor loading information is approximate and does not incorporate different option configurations. It should be used only with adequate safety factors.

SPECIFICATIONS

Model	GS-2646	
Height, working maximum	32 ft	9.9 m
Height, platform maximum	26 ft	7.9 m

Models with sliding rails

Height, stowed maximum Rails up - CE	89 ⁷ / ₈ in	2.28 m
Height, stowed maximum Rails up - ANSI	85 ¹ / ₂ in	2.17 m
Height, stowed maximum Rails lowered	85 ¹ / ₂ in	2.17 m
Height, stowed maximum Rails off	46 ¹ / ₈ in	1.17 m

Height, guard rails - ANSI, CSA and Australia	39 in	99.1 cm
Height, guard rails - CE	43 in	1.1 m

Models with folding rails

Height, stowed maximum	89 ⁷ / ₈ in	2.28 m
Height, stowed maximum Rails folded	68 ¹ / ₈ in	1.73 m
Platform height, Stowed maximum	46 ¹ / ₈ in	1.17 m

All models

Width	46 in	1.17 m
Length, stowed	96 in	2.44 m
Length, platform extended	135 in	3.44 m
Maximum load capacity	1000 lbs	454 kg
Wheelbase	73 in	1.85 m
Turning radius (outside)	92 in	2.34 m
Turning radius (inside)	0 in	0 cm
Ground clearance	4 in	10.2 cm
Ground clearance Pothole guards deployed	7 ⁷ / ₈ in	2.2 cm

Weight See Serial Plate
(Machine weights vary with option configurations)

Gradeability	30%	
Airborne noise emissions Maximum sound level at normal operating workstations (A-weighted)	>70 dB	
Power source	4 Batteries, 6V 245AH	
Controls	Proportional	
AC outlet in platform	standard	
Maximum hydraulic pressure (functions)	3500 psi	241.3 bar
Tires size	15 x 5 x 11 ¹ / ₄	
Hydraulic system capacity	5.5 gallons	20.8 liters

Platform dimensions

Length x width	89 x 45 ³ / ₄ in 2.26 m x 1.16 m	
Platform extension length	39 in	99 cm

Drive speeds

Stowed, maximum	2.2 mph	3.5 km/h
Platform raised, maximum	0.5 mph 0.8 km/h 40 ft/54.5 sec 12.2 m/54.5 sec	

Floor Loading Information	ANSI	CE
	CSA & Australia	
GVW+Rated Load	5646 lbs 2561 kg	6227 lbs 2825 kg
Axle load, maximum	3100 lbs 1406 kg	3726 lbs 1690 kg
Wheel load, maximum	1550 lbs 703 kg	1863 lbs 845 kg
Localized pressure per tire	155 psi 10.91 kg/cm ² 1069 kPa	186.3 psi 13.11 kg/cm ² 1284 kPa
Occupied pressure	199 psf 9.51 kPa	219 psf 10.49 kPa

Note: Floor loading information is approximate and does not incorporate different option configurations. It should be used only with adequate safety factors.

SPECIFICATIONS

Model	GS-3246	
Height, working maximum	38 ft	11.75 m
Height, platform maximum	32 ft	9.75 m
Models with sliding rails		
Height, stowed maximum Rails up - CE	95 in	2.41 m
Height, stowed maximum Rails up - ANSI	90 ¹ / ₂ in	2.3 m
Height, stowed maximum Rails lowered	83 ³ / ₄ in	2.13 m
Height, stowed maximum Rails off	51 ¹ / ₄ in	1.3 m
Height, guard rails - ANSI, CSA and Australia	39 in	99.1 cm
Height, guard rails - CE	43 ¹ / ₂ in	1.1 m
Models with folding rails		
Height, stowed maximum	95 in	2.41 m
Height, stowed maximum Rails folded	73 ³ / ₈ in	1.86 m
Platform height, Stowed maximum	51 ¹ / ₄ in	1.3 m
All models		
Width	46 in	1.17 m
Length, stowed	96 in	2.44 m
Length, platform extended	135 in	3.44 m
Maximum load capacity	700 lbs	318 kg
Wheelbase	73 in	1.85 m
Turning radius (outside)	92 in	2.34 m
Turning radius (inside)	0 in	0 cm
Ground clearance	4 in	10.2 cm
Ground clearance Pothole guards deployed	⁷ / ₈ in	2.2 cm
Weight	See Serial Plate (Machine weights vary with option configurations)	

Gradeability	25%	
Airborne noise emissions	>70 dB	
Maximum sound level at normal operating workstations (A-weighted)		
Power source	4 Batteries, 6V 245AH	
Controls	Proportional	
AC outlet in platform	standard	
Maximum hydraulic pressure (functions)	3500 psi	241.3 bar
Tires size	15 x 5 x 11 ¹ / ₄	
Hydraulic system capacity	5.5 gallons	20.8 liters

Platform dimensions

Length x width	89 x 45 ³ / ₄ in 2.26 m x 1.16 m	
Platform extension length	39 in	99 cm

Drive speeds

Stowed, maximum	2.2 mph 3.5 km/h	
Platform raised, maximum	0.5 mph 0.8 km/h 40 ft/54.5 sec 12.2 m/54.5 sec	

Floor Loading Information

GVW+Rated Load	6872 lbs	3117 kg
Axle load, maximum	4040 lbs	1833 kg
Wheel load, maximum	2020 lbs	916 kg
Localized pressure per tire	202 psi	14.21 kg/cm ² 1393 kPa
Occupied pressure	242 psf	11.57 kPa

Note: Floor loading information is approximate and does not incorporate different option configurations. It should be used only with adequate safety factors.

Genie Holland
Phone +31 70 51 78836
Fax +31 70 51 13993

Genie Scandinavia
Phone +46 31 3409612
Fax +46 31 3409613

Genie France
Phone +33 (0)2 37 26 09 99
Fax +33 (0)2 37 26 09 98

Genie Ibérica
Phone +34 93 579 5042
Fax +34 93 579 5059

Genie Germany
Phone +49 (0)4202 88520
Fax +49 (0)4202 8852-20

Genie U.K.
Phone +44 (0)1476 584333
Fax +44 (0)1476 584334

Genie Mexico City
Phone +52 55 5666 5242
Fax +52 55 5666 3241

Genie North America
Phone 425.881.1800
Toll Free USA and Canada
800.536.1800
Fax 425.883.3475

Genie Australia Pty Ltd.
Phone +61 7 3375 1660
Fax +61 7 3375 1002

Genie China
Phone +86 21 53852570
Fax +86 21 53852569

Genie Malaysia
Phone +60 4 228 1235
Fax +60 4 226 6872

Genie Japan
Phone +81 3 3453 6082
Fax +81 3 3453 6083

Genie Korea
Phone +82 2 558 7267
Fax +82 2 558 3910

Genie Africa
Phone +27 11 455 0373
Fax +27 11 455 0355

Genie Latin America
Phone +55 11 4055 2499
Fax +55 11 4043 1661

Distributed By: